

ANNEX 8**RESOLUTION MSC.222(82)****(adopted on 8 December 2006)****ADOPTION OF AMENDMENTS TO THE INTERNATIONAL CODE
OF SAFETY FOR HIGH-SPEED CRAFT, 2000**

THE MARITIME SAFETY COMMITTEE,

RECALLING Article 28(b) of the Convention on the International Maritime Organization concerning the functions of the Committee,

NOTING resolution MSC.97(73), by which it adopted the International Code of Safety for High-Speed Craft, 2000 (hereinafter referred to as “the 2000 HSC Code”), which has become mandatory under chapter X of the International Convention for the Safety of Life at Sea (SOLAS), 1974, (hereinafter referred to as “the Convention”),

NOTING ALSO article VIII(b) and regulation X/1.2 of the Convention concerning the procedure for amending the 2000 HSC Code,

HAVING CONSIDERED, at its eighty-second session, amendments to the 2000 HSC Code proposed and circulated in accordance with article VIII(b)(i) of the Convention,

1. ADOPTS, in accordance with article VIII(b)(iv) of the Convention, amendments to the International Code of Safety for High-Speed Craft, 2000, the text of which is set out in the Annex to the present resolution;
2. DETERMINES, in accordance with article VIII(b)(vi)(2)(bb) of the Convention, that the amendments shall be deemed to have been accepted on 1 January 2008 unless, prior to that date, more than one third of the Contracting Governments to the Convention or Contracting Governments the combined merchant fleets of which constitute not less than 50% of the gross tonnage of the world’s merchant fleet, have notified their objections to the amendments;
3. INVITES Contracting Governments to note that, in accordance with article VIII(b)(vii)(2) of the Convention, the amendments shall enter into force on 1 July 2008 upon their acceptance in accordance with paragraph 2 above;
4. REQUESTS the Secretary-General, in conformity with article VIII(b)(v) of the Convention, to transmit certified copies of the present resolution and the text of the amendments contained in the Annex to all Contracting Governments to the Convention;
5. FURTHER REQUESTS the Secretary-General to transmit copies of this resolution and its Annex to Members of the Organization, which are not Contracting Governments to the Convention.

ANNEX*

**AMENDMENTS TO THE INTERNATIONAL CODE OF SAFETY
FOR HIGH-SPEED CRAFT, 2000**

**CHAPTER 1
GENERAL COMMENT AND REQUIREMENTS**

1 The existing text of section 1.2 is renumbered as paragraph 1.2.1 and the following paragraph 1.2.2 is added:

“1.2.2 On all craft, new installation of materials containing asbestos used for the structure, machinery, electrical installations and equipment of a craft to which this Code applies shall be prohibited except for:

- .1 vanes used in rotary vane compressors and rotary vane vacuum pumps;
- .2 watertight joints and linings used for the circulation of fluids when, at high temperature (in excess of 350°C) or pressure (in excess of 7×10^6 Pa), there is a risk of fire, corrosion or toxicity; and
- .3 supple and flexible thermal insulation assemblies used for temperatures above 1000°C.”

2 In paragraph 1.3.4.1, the words “operational speed” are replaced by the words “90% of maximum speed”.

3 In paragraph 1.3.4.2, the words “operational speed” are replaced by the words “90% of maximum speed”.

4 In paragraph 1.4.16, the words “(main displays and controls for equipment specified in 13.2 to 13.7)” are inserted after the words “navigating equipment”.

5 In paragraph 1.4.29, the word “food” is inserted between the words “cooking or” and “heating”.

6 The existing paragraph 1.4.35 is replaced by the following:

“1.4.35 *Machinery spaces* are spaces containing internal combustion engines either used for main propulsion or having an aggregate total power output of more than 110 kW, generators, oil fuel units, major electrical machinery and similar spaces and trunks to such spaces.”

7 The existing paragraph 1.4.44 is deleted and the existing paragraphs 1.4.32 to 1.4.43 are renumbered as paragraphs 1.4.33 to 1.4.44, with a new paragraph 1.4.32 being inserted as follows:

* The annex also contains at the end a list of footnotes to be added or to be amended in the 2000 HSC Code.

“1.4.32 *IMDG Code* means the International Maritime Dangerous Goods (IMDG) Code as defined in chapter VII of the Convention.”

8 At end of paragraph 1.4.53, the following new sentence is inserted:

“Such spaces containing no cooking appliances may contain:

- .1 coffee automats, toasters, dish washers, microwave ovens, water boilers and similar appliances, each of them with a maximum power of 5 kW; and
- .2 electrically heated cooking plates and hot plates for keeping food warm, each of them with a maximum power of 2 kW and a surface temperature not above 150°C.”

9 In paragraph 1.4.54, the text after “the average” is replaced by the following:

“crest-to-trough height of the highest one third of the zero-upcrossing waves in a specified period.”

10 At end of paragraph 1.8.1, the following text is inserted:

“On all craft, all certificates issued under this chapter, or certified copies thereof, shall be carried on the craft. Except where the flag State is a Party to the 1988 SOLAS Protocol, a copy of each of these certificates shall be posted up in a prominent and accessible place in the craft.”

11 In paragraph 1.9.1, the second sentence is deleted and the following new paragraph 1.9.1.1 is inserted:

“1.9.1.1 On all craft, transit voyages may be undertaken without a valid Permit to Operate High-Speed Craft provided the craft is not operating commercially with passengers or cargo onboard. For the purpose of this provision, these transit voyages include delivery voyages, i.e., builder’s port to base port, and voyages for repositioning purposes, i.e., change of base port and/or route. Such transit voyages in excess of the limits set out in this Code may be undertaken provided that:

- .1 the craft has a valid High-Speed Craft Safety Certificate or similar before the start of such a voyage;
- .2 the operator has developed a safety plan for the voyage including any temporary accommodation and all relevant matters listed in 18.1.3 to ensure that the craft is capable of safely completing the transit voyage;
- .3 the master of the craft is provided with the materials and information necessary to operate the craft safely during the transit voyage; and
- .4 the Administration is satisfied that arrangements have been made for the safe conduct of the voyage.”

- 12 The following new paragraph 1.9.7 is added after the existing paragraph 1.9.6:

“1.9.7 In determining the worst intended conditions and the operational limitations on all craft for insertion in the Permit to Operate, the Administration shall give consideration to all the parameters listed in annex 12. The limitations assigned shall be those that enable compliance with all of these factors.”

- 13 In paragraph 1.15.1, the words “four years” are replaced by the words “six years”.

CHAPTER 2 BUOYANCY, STABILITY AND SUBDIVISION

- 14 The existing text of subparagraph .1 of paragraph 2.1.3 is replaced by the following:

“.1 *Downflooding point* means any opening, irrespective of size, that would permit passage of water through a water/weathertight structure (e.g., opening windows), but excludes any opening kept closed to an appropriate standard of water/weathertightness at all times other than when required for access or for operation of portable submersible bilge pumps in an emergency (e.g., non-opening windows of similar strength and weathertight integrity to the structure in which they are installed).”

- 15 In paragraph 2.1.3, subparagraphs .2 to .6 are renumbered as subparagraphs .3 to .7 and the following new subparagraph .2 is inserted after the existing subparagraph .1:

“.2 *Elsewhere* when applied to sill and coaming heights in 2.2.7 and 2.2.8 is taken as applying to all weathertight and watertight closures located on or below the datum.”

- 16 The following new paragraph 2.1.5 is inserted and the existing paragraphs 2.1.5 and 2.1.6 are renumbered as paragraphs 2.1.6 and 2.1.7:

“2.1.5 The adequacy of mathematical simulations must first be demonstrated by correlation with full-scale or model tests for the appropriate type of craft. It may be appropriate to use mathematical simulations to help to identify the more critical scenarios for subsequent physical testing.*”

* Some mathematical simulation methods are not well suited to accurate modelling of extreme events. For safety level 3 or 4, it may be appropriate to use model testing as a precursor to, or instead of, full-scale testing.

- 17 The following text is inserted at the end of paragraph 2.1.7:

“Where calculations are employed, it shall first be shown that they correctly represent dynamic behaviour within the operational limitations of the craft.”

- 18 The third and subsequent sentences of paragraph 2.2.9.3 are replaced by the following:

“In unmanned machinery spaces, main and auxiliary sea inlet and discharge controls in connection with the operation of machinery shall either:

- .1 be located at least 50% of the significant wave height corresponding to the worst intended conditions above the deepest flooded waterline following damage specified in 2.6.6 to 2.6.10; or
- .2 be operable from the operating compartment.”

19 In paragraph 2.3.4, the content of table 2.3.4 is replaced by the following:

“Table 2.3.4 – Application of annexes 7 and 8 to monohull and multihull craft

GM _T	Angle of maximum GZ	
	≤ 25°	> 25°
≤ 3 m	annex 7 or annex 8	annex 8
> 3 m	annex 7	annex 7 or annex 8

20 In paragraph 2.3.4, the definitions of B_{WL} , A_{WP} and ∇ which appear after “where:” are deleted and the definition “GZ = righting lever” is inserted to replace them.

21 In paragraph 2.4.2, the words “chapter 18” are replaced by the words “chapters 17 and 18”.

22 In paragraph 2.6.5, the following new subparagraph .5 is inserted after the existing subparagraph .4:

“.5 void spaces filled with foam or modular buoyancy elements or any space without a venting system are considered to be void spaces for the purposes of this paragraph, provided such foam or elements fully comply with 2.6.4.”

23 In paragraph 2.6.6, the final sentence is deleted.

24 The following new section of text is added in continuation of paragraph 2.6.7 after subparagraph 2.6.7.3:

“The damages described in this paragraph shall be assumed to have the shape of a parallelepiped.* Applying this to figure 2.6.7 a, the inboard face at its mid-length shall be tangential to, or otherwise touching in a least 2 places, the surface corresponding to the specified transverse extent of penetration, as illustrated in figure 2.6.7 a.

Side damage shall not transversely penetrate a greater distance than the extent of $0.2\nabla^{1/3}$ at the design waterline, except where a lesser extent is provided for in 2.6.7.2. Refer to figures 2.6.7b and c.

* A parallelepiped is defined as “a solid contained by parallelograms” and a parallelogram is defined as “a four-sided rectilinear figure whose opposite sides are parallel”.

If considering a multihull, the periphery of the craft is considered to only be the surface of the shell encompassed by the outboard surface of the outermost hull at any given section.

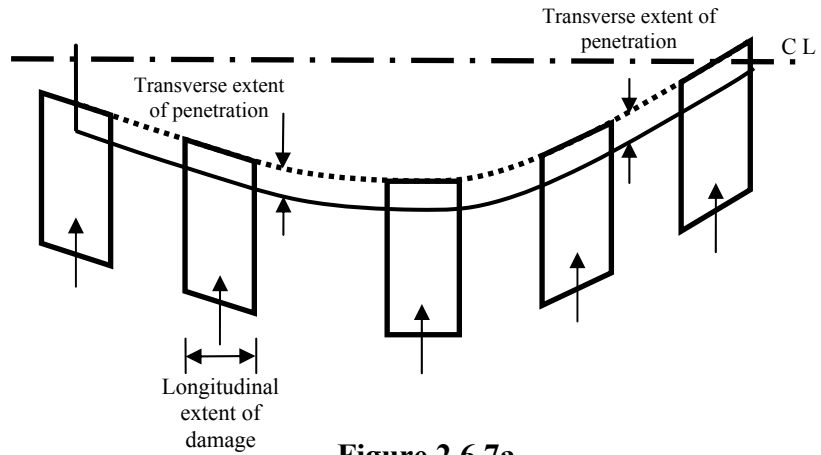

Figure 2.6.7a

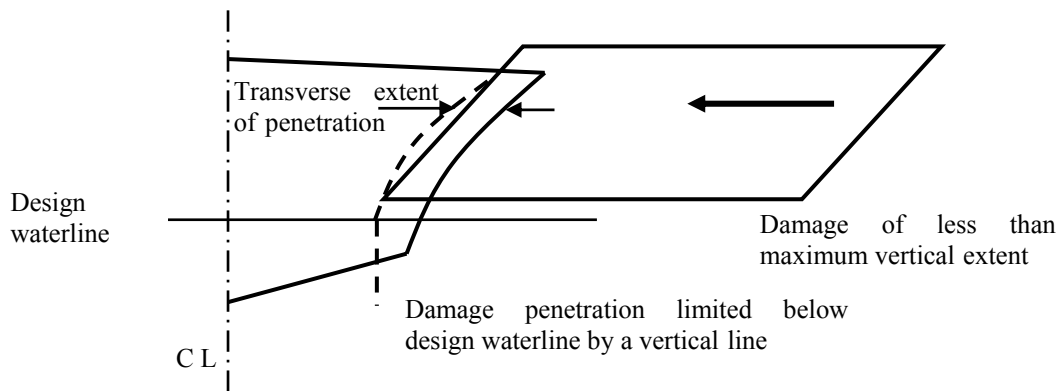

Figure 2.6.7 b

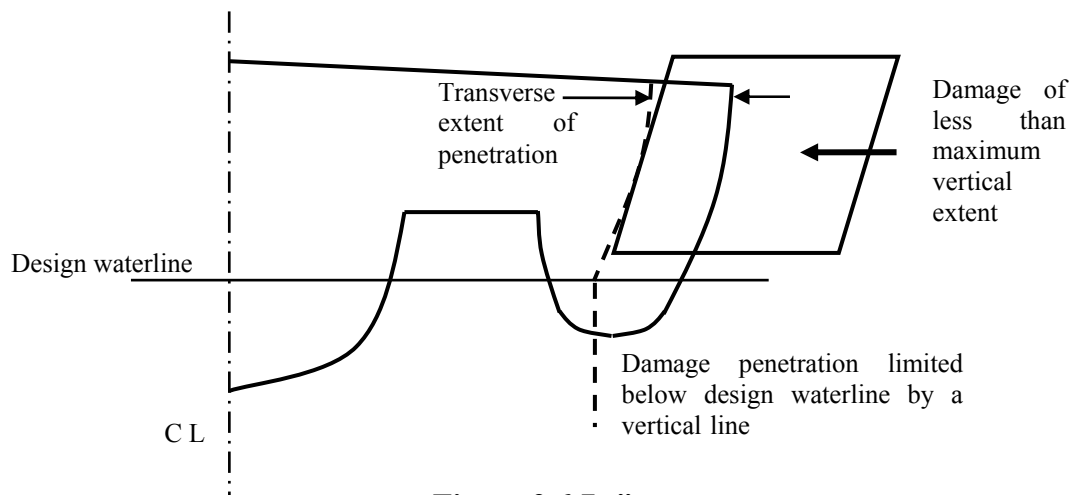

Figure 2.6.7 c''

25 In paragraph 2.6.7, the word “damages” is replaced by the word “damage”.

26 Existing paragraphs 2.6.8 to 2.6.12 are renumbered as paragraphs 2.6.9 to 2.6.13 and the following new paragraph 2.6.8 is inserted after the existing paragraph 2.6.7:

“2.6.8 Extent of bow and stern damage

2.6.8.1 The following extents of damage are to be applied to bow and stern, as illustrated in figure 2.6.8:

- .1 at the fore end, damage to the area defined as A_{bow} in 4.4.1, the aft limit of which being a transverse vertical plane, provided that this area need not extend further aft from the forward extremity of the craft’s watertight envelope than the distance defined in 2.6.7.1; and
- .2 at the aft end, damage to the area aft of a transverse vertical plane at a distance $0.2\nabla^{1/3}$ forward of the aft extremity of the watertight envelope of the hull.

2.6.8.2 The provisions of 2.6.6 in relation to damage of lesser extent remain applicable to such damage.

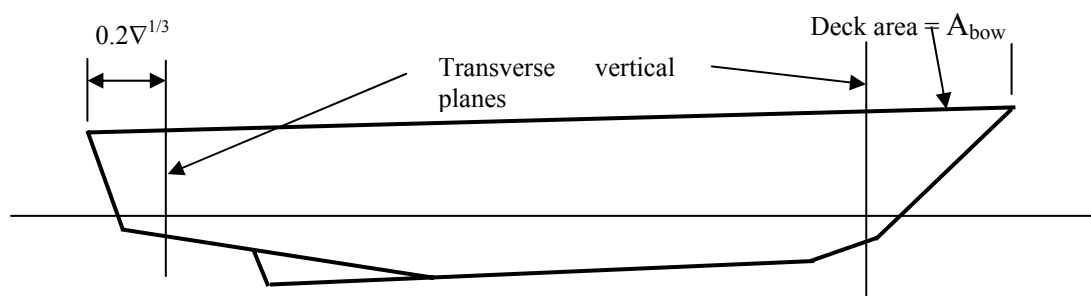

Figure 2.6.8”

27 In paragraph 2.6.9.1.1.1, the words “operational speed” are replaced by the words “90% of maximum speed”.

28 In paragraph 2.6.9.1.2, the following text is inserted at the end of the definition of “T”:

“, provided that structures such as single plate skegs or solid metal appendages shall be considered to be non-buoyant and thus excluded.”

29 The following new paragraph 2.6.9.2.3 is inserted after the existing paragraph 2.6.9.2.2:

“2.6.9.2.3 The shape of damage shall be assumed to be rectangular in the transverse plane as illustrated in figure 2.6.9.2 below. Damage is to be assumed at a series of sections within the defined longitudinal extent in accordance with figure 2.6.9.2, the mid-point of the damaged girth being maintained at a constant distance from the centreline throughout that longitudinal extent.

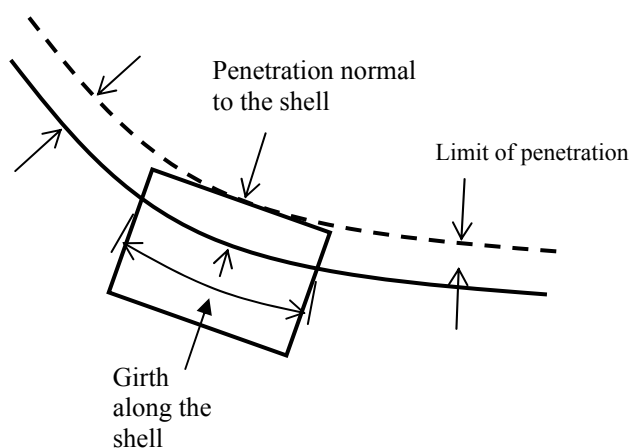

Figure 2.6.9.2

30 In paragraph 2.6.10.1, the words “below the design waterline” are inserted between the words “hull(s)” and “which”.

31 In paragraph 2.6.10.2, the following new subparagraph .4 is inserted after the existing subparagraph .3:

“.4 the shape of damage shall be assumed to be rectangular in the plane of the shell of the craft, and rectangular in the transverse plane as illustrated in figure 2.6.9.2.”

32 The existing paragraphs 2.7.2 to 2.7.8 are renumbered as paragraphs 2.7.3 to 2.7.9 and the following new paragraph 2.7.2 is inserted after the existing paragraph 2.7.1:

“2.7.2 On all craft, where an accurate inclining experiment is impractical owing to the height of the centre of gravity (VCG or KG) being less than one third of the transverse metacentric height (GM_T), the Administration may accept estimation of KG by detailed calculation in place of an inclining experiment. In such cases, a displacement check shall be undertaken to confirm the calculated lightship characteristics, including LCG, which may be accepted if the measured lightship displacement and LCG are respectively within 2% and 1% L relative to the estimate.”

33 In paragraph 2.7.7, the following new sentence is inserted at the end of the paragraph:

“For amphibious air-cushion vehicles this may be achieved by the use of draught gauges in conjunction with deck datum plates.”

34 In paragraph 2.10, the following new subparagraphs .7 to .10 are inserted after the existing subparagraph .6:

“.7 Passengers assumed to be occupying seats shall be taken as having a vertical centre of gravity corresponding to being seated, with all others standing.

.8 On the decks where assembly stations are located, the number of passengers on each deck shall be that which generates the maximum heeling moment. Any remaining passengers shall be assumed to occupy decks adjacent to those on which the assembly stations are located, and positioned such that the combination

of number on each deck and total heeling moment generate the maximum static heel angle.

- .9 Passengers shall not be assumed to gain access to the weather deck nor be assumed to crowd abnormally towards either end of the craft unless this is a necessary part of the planned evacuation procedure.
- .10 Where there are seats in areas occupied by passengers, one passenger per seat shall be assumed, passengers being assigned to the remaining free areas of the deck (including stairways, if appropriate) at the rate of four per square metre.”
- 35 The following new paragraph 2.12.3 is inserted after the existing paragraph 2.12.2:

“2.12.3 Demonstrating the effect of the passenger heeling moment calculated as given by 2.10 above, or a defined beam wind pressure when at speed, shall be established by conducting a trial or model test with an equivalent heeling moment applied by test weights. Passenger movement may only be neglected on craft where the safety announcement (refer to 8.4.1 and 18.7) expressly requires passengers to remain seated throughout the voyage.”

CHAPTER 4 ACCOMMODATION AND ESCAPE MEASURES

- 36 In paragraph 4.3.4, the words “two thirds of operational speed” are replaced by the words “60% of maximum speed”.
- 37 In paragraph 4.3.7, the words “operational speed” are replaced by the words “90% of maximum speed”.
- 38 In paragraph 4.4.1, the words “operational speed” are replaced by the words “90% of maximum speed”.
- 39 In table 4.4.2, under Design Level 2:
- .1 the existing text of paragraph 1.1 is replaced by the following:
- “1.1 Seatbacks with protective deformation and padding.”; and
- .2 the text “unless satisfactorily tested without belts in that orientation and arrangement” is inserted at the end of paragraph 1.4.
- 40 The following new sentence is inserted at the end of paragraph 4.4.5:
- “The armrests and backrests of seats in public spaces may serve as handholds.”
- 41 In paragraph 4.6.1, the reference to “3g” is replaced by the reference to “3”.

42 In paragraph 4.7.10, the second sentence is replaced by the following:

“Clear markings, including the location of the fire control plan, shall be provided for the guidance of rescue personnel outside the craft.”

43 In paragraph 4.7.12, the following text is added at the end of the paragraph:

“Doors providing escape from a space shall, where possible, be situated at opposite ends of the space. Where the doors providing escape from a space are situated in the same end of the space, the distance between those doors shall be greater than the maximum length of the space.”

44 In paragraph 4.7.13, the following text is added at the end of the paragraph:

“Requirements of this paragraph do not apply to aisles (fore-aft passageways separating seating areas) or to spaces between adjacent rows of seats. However, the width of aisles and the seat pitch shall be such as to allow the craft to comply with the provisions of 4.8.”

45 The existing paragraphs 4.7.14 to 4.7.16 are renumbered as paragraphs 4.7.15 to 4.7.17 respectively, and the following new paragraph 4.7.14 is inserted:

“4.7.14 Special category spaces used for stowage of motor vehicles shall be provided with walkways having a width of at least 600 mm leading to a safe means of escape.”

46 In paragraph 4.7.17, the following new sentence is added at the end of the paragraph:

“At least one means of escape from a machinery space shall consist of either a ladder leading to a door or hatch (not being a horizontal flush-hatch) or a door located in the lower part of that space and giving access to an adjacent compartment from which a safe means of escape is provided.”

47 The following new paragraph 4.7.18 is inserted after the existing paragraph 4.7.17:

“4.7.18 Spaces that are only entered occasionally by crew members may have only one means of escape provided that it is independent of watertight doors.”

48 In paragraph 4.8.1, the following new sentence is added at the end of the paragraph:

“In determining the evacuation time, all means of escape are to be considered serviceable and they need not be dimensioned to take into account any additional number of persons that might be diverted from other means of escape if one or more of those other means of escape are lost or rendered unserviceable.”

49 The existing paragraphs 4.8.10 and 4.8.11 are renumbered as paragraphs 4.8.11 and 4.8.12 and the following new paragraph 4.8.10 inserted:

“4.8.10 Where the Administration is satisfied that the evacuation time determined in accordance with 4.8.1 to 4.8.9 can thereby be accurately estimated, the Administration may accept an evacuation demonstration in which persons are not required to descend through MES or equivalent means of evacuation, provided the time required to embark into the survival craft can be determined using:

- .1 data obtained from the type-approval tests of the equipment, increased by a factor based on the guidelines developed by the Organization; or
- .2 time extrapolated from trials using a limited number of participants.”

* Refer to the Guidelines for a simplified evacuation analysis of high-speed passenger craft (MSC/Circ.1166), in particular paragraph 3.5.1 thereof.

CHAPTER 6 ANCHORING, TOWING AND BERTHING

50 The following new paragraph 6.1.4 is inserted after the existing paragraph 6.1.3:

“6.1.4 Under any operating load up to the breaking strength of the anchor cable or mooring lines, the loads on the bitts, bollards, etc., shall not result in damage to the hull structure that will impair its watertight integrity. A strength margin of at least 20% above the resultant load based on the minimum specified breaking strength of the relevant cable or warp shall be required.”

CHAPTER 7 FIRE SAFETY

51 In paragraph 7.3.1.2, in the first bullet point, the reference to “1.4.4” is replaced by the reference to “1.4.5”.

52 In paragraph 7.3.1.3, in the first bullet point, the reference to “1.4.5” is replaced by the reference to “1.4.6”.

53 In paragraph 7.3.1.4, the words “as defined in 1.4.15” are replaced by the words “as defined in 1.4.16”.

54 The existing paragraph 7.3.2 is renumbered as paragraph 7.3.3 and the following new paragraph 7.3.2 is inserted:

“7.3.2 In relation to the classification of spaces in 7.3.1, the following additional criteria shall be applied:

- .1 If a space is divided by partial bulkheads into two (or more) smaller areas such that they form enclosed spaces, then the enclosed spaces shall be surrounded by bulkheads and decks in accordance with tables 7.4-1 and 7.4-2, as applicable. However, if the separating bulkheads of such spaces are at least 30% open, then the spaces may be considered as the same space.
- .2 Cabinets having a deck area of less than 2 m² may be accepted as part of the space they serve, provided they have open ventilation to the space and do not contain any material or equipment that could be a fire risk.

- .3 Where a space has the special characteristics of two or more space groupings, the structural fire protection time of the divisions shall be the highest for the space groupings concerned. For example, the structural fire protection time of the divisions of emergency generator rooms shall be of the highest value for the space when the space is considered as being a control station (D) and a machinery space (A).”

55 The following new paragraphs 7.3.4 to 7.3.6 and associated figures 7.3.4a, 7.3.4b and 7.3.6 are inserted after the existing paragraph 7.3.3:

“7.3.4 To prevent heat transmission at intersections and terminal points, the insulation of the deck or bulkhead shall be carried past the intersection or terminal point for a distance of at least 450 mm in the case of steel or aluminium structures (refer to figures 7.3.4a and 7.3.4b).

7.3.5 If a space is divided by a deck or bulkhead and the fire insulation required for each space is different, the insulation with the higher structural fire protection time shall continue on the deck or bulkhead with the insulation of the lesser structural fire protection time for a distance of at least 450 mm beyond the boundary between the spaces.

7.3.6 Where the lower part of the fire insulation has to be cut for drainage, the construction shall be in accordance with the structural details shown in figure 7.3.6.”

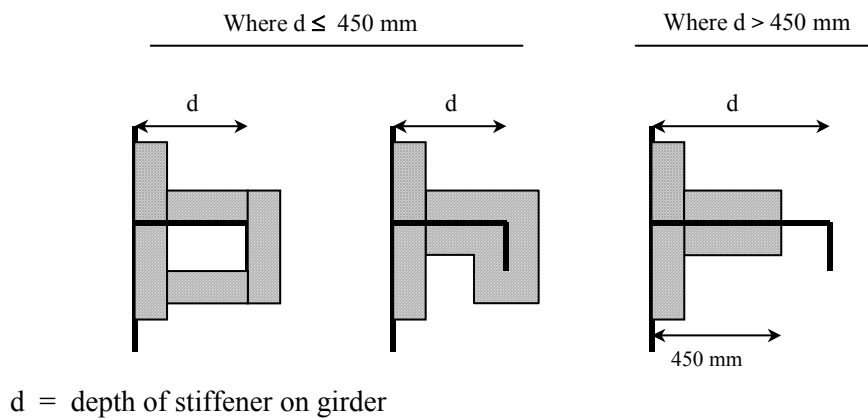

Figure 7.3.4a

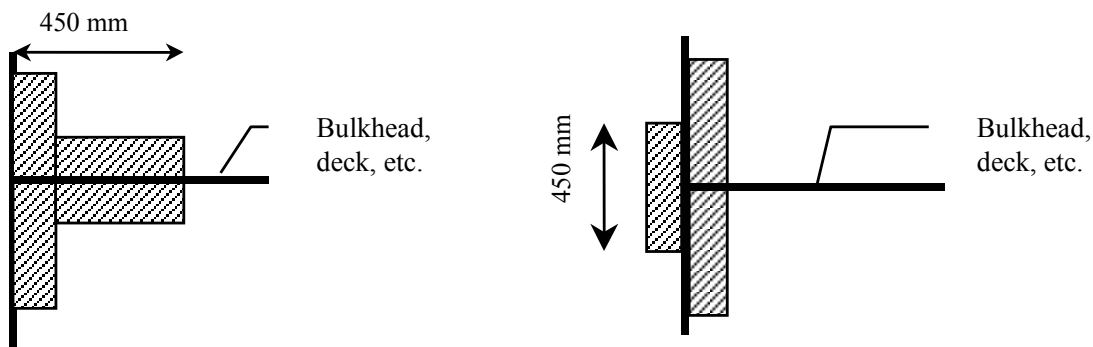

Figure 7.3.4b

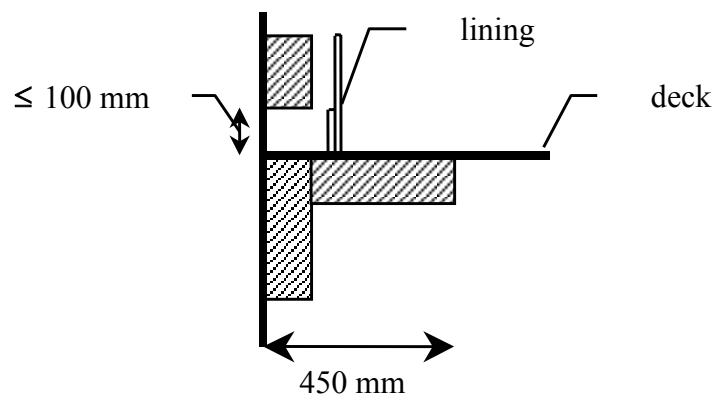

Figure 7.3.6

56 The following new paragraph 7.4.1.4 is inserted after the existing paragraph 7.4.1.3:

“7.4.1.4 Paragraph 7.4.1.3 does not apply to appendages such as air propellers, air ducts to propellers, transmission shafts, rudders and other control surfaces, struts, spars, flexible skirts, etc., which do not comprise part of the main structure of the craft.”

57 In tables 7.4-1 and 7.4-2, note 1 is replaced by the following:

“1 The upper side of decks within spaces protected by fixed fire-extinguishing systems need not be insulated.”

58 In paragraph 7.4.2.1, in the second sentence, the words “at the lightweight condition” are replaced by the words “at least 300 mm below the craft’s waterline in the lightweight condition in displacement mode”.

59 At the end of paragraph 7.4.2.6, the following new sentence is added:

“Where machinery shafts penetrate fire-resisting watertight divisions, arrangements shall be made to ensure that the required watertight and fire-resisting integrity of the division is not impaired.”

60 The following new paragraph 7.4.2.7 is inserted after the existing paragraph 7.4.2.6:

“7.4.2.7 Ventilation openings may be accepted in entrance doors to public toilets, provided they are positioned in the lower portion of the door and fitted with closable grilles made of non-combustible or fire-restricting material and operable from outside the space.”

61 At the end of paragraph 7.4.3.2, the following sentence is added:

“The fire insulation in such spaces may be covered by metal sheets (not perforated) or by vapour proof glass cloth sealed at joints.”

62 In paragraph 7.4.3.3.1, the words “e.g., desks, wardrobes, dressing tables, bureaux and dressers” are inserted after the words “case furniture”.

63 In paragraph 7.4.3.4, the words “Subject to 7.4.3.5” are inserted at the beginning of the paragraph.

64 The following new paragraph 7.4.3.5 is inserted after the existing paragraph 7.4.3.4 and the existing paragraphs 7.4.3.5 to 7.4.3.10 are renumbered as paragraphs 7.4.3.6 to 7.4.3.11:

“7.4.3.5 Paragraph 7.4.3.4 does not apply to partitions, windows and sidescuttles made of glass which are deemed to be non-combustible and to comply with the requirements for low-flame spread surfaces or to items and materials referred to in 7.4.3.3*.”

* Refer to paragraph 7.9.3.4 and the FTP Code, annex 2, paragraphs 1 and 5.1.

65 The last sentence of paragraph 7.4.4.1 is deleted.

66 The following new paragraph 7.4.4.2 is added after the existing paragraph 7.4.4.1 and the existing paragraphs 7.4.4.2 and 7.4.4.3 are renumbered as paragraphs 7.4.4.3 and 7.4.4.4:

“7.4.4.2 Open stairways may be fitted in public spaces consisting of only two decks, provided the stairways lie wholly within such public spaces and the following conditions are met:

- .1 all levels are used for the same purpose;
- .2 the area of the opening between the lower and upper parts of the space is at least 10% of the deck area between the upper and lower parts of the space;
- .3 the design is such that persons within the space should be generally aware, or could easily be made aware of, a developing fire or other hazardous situation located within that space;
- .4 sufficient means of escape are provided from both levels of the space directly leading to an adjacent safe area or compartment; and
- .5 the whole space is served by one section of the sprinkler system.”

67 The second sentence of paragraph 7.4.4.4 is replaced by the following:

“Draught stops are not required in public spaces of category A craft having only one public space and on other craft in spaces with open ceilings (perforated ceilings) where the opening is 40% or more and the ceiling is arranged in such a way that a fire behind the ceiling can be easily seen and extinguished.”

68 The following sentence is added at the end of paragraph 7.5.2:

“The use of aluminium in lubricating oil sump tanks for engines, or in lubricating oil filter housings fitted integral with the engines, is accepted.”

69 In paragraph 7.6.1, the following sentence is inserted between the two existing sentences:

“The controls shall be easily accessible as well as prominently and permanently marked and shall indicate whether the shut-off is open or closed.”

70 In paragraph 7.6.3.2, the words “(the junction between the duct and the galley range hood)” are inserted after the words “lower end of the duct”.

71 In paragraph 7.6.3.4, the word “means” is replaced by the words “a remote means located with the above controls”.

72 The following sentence is added at the end of the existing paragraph 7.6.3.5:

“At minimum, one hatch shall be provided close to the exhaust fan and others located in areas of high grease accumulation such as the lower end of the duct as referred to in 7.6.3.2.”

73 The following text is added at the end of the existing paragraph 7.6.4:

“Fire and smoke dampers shall be arranged so as to be readily accessible. Where placed behind ceilings or linings, they shall be provided with an inspection door marked to identify the damper. Such identification shall also be placed on any required remote controls.”

74 In paragraph 7.6.6, the following sentence is inserted before the last sentence:

“Manual closing may be achieved by mechanical means of release or by remote operation of the fire or smoke damper by means of a fail-safe electrical switch or pneumatic release (i.e. spring-loaded, etc.).”

75 In paragraph 7.7.1, the following sentence is inserted after the first sentence:

“Control stations not normally occupied (e.g., emergency generator rooms) need not be provided with manually operated call points.”

76 In paragraph 7.7.1.1.4, the words “, each of which shall comprise a group of fire detectors and manually operated call points as displayed at the indicating unit(s) required by this paragraph” are added at the end of the first sentence.

77 In paragraph 7.7.1.1.9, in the first sentence, the text after “7.11.1” is deleted and a new sentence is added at the end of the paragraph as follows:

“Notwithstanding the preceding requirements of this paragraph, the Administration may accept that the same section of detectors can serve spaces on more than one deck if such spaces are located in the fore or aft end of the craft or they are so arranged that they constitute common spaces on different decks (e.g., fan rooms, galleys, public spaces, etc.).”

78 The following sentence is added at the end of paragraph 7.7.1.1.10:

“In the case of a fire detection system with remotely and individually identifiable fire detectors, this requirement is met if no machinery spaces of a major fire hazard are included in a loop (electrical circuit linking detectors of various sections in a sequence

and connected (input and output) to the indicating unit(s)) covering accommodation spaces, service spaces and control stations.”

79 In paragraph 7.7.1.1.14, the text following the words “except that” is replaced by the following:

“the control panel may be used to activate one or more of the following:

- .1 paging system;
- .2 fan stops;
- .3 closure of fire doors;
- .4 closure of fire and smoke dampers; and
- .5 sprinkler system.”

80 In paragraph 7.7.1.1.15, the text of the chapeau is replaced by the following:

“Fire detection systems in which all fire detectors are individually identifiable (i.e. having zone address identification capability) shall be so arranged that:”

81 In paragraph 7.7.1.1.15.1, the following words are added at the end of the paragraph:

“and no loop shall pass through a space twice. When this is not practical (e.g., for large public spaces), the part of the loop which by necessity passes through the space for a second time shall be installed at the maximum possible distance from the other parts of the loop.”

82 In paragraph 7.7.1.1.15.2, the word “not” is inserted between the words “shall” and “render”.

83 The following new paragraph 7.7.1.1.16 is inserted after the existing paragraph 7.7.1.1.15:

“The fire detection system in vehicle deck spaces, excluding manual call points, may be switched off with a timer during loading/unloading of vehicles.”

84 The last sentence of paragraph 7.7.1.2.3 is replaced by the following:

“Detectors which are located in the overhead shall be a minimum distance of 0.5 m away from bulkheads, except in corridors, lockers and stairways.”

85 In the first sentence of paragraph 7.7.3.1, the words “operating compartment and, where provided, from a” are inserted between the words “the” and “control”.

86 The following new paragraph 7.7.3.2 is inserted after the existing paragraph 7.7.3.1 and the existing paragraphs 7.7.3.2 and 7.7.3.3 are renumbered as paragraphs 7.7.3.3 and 7.7.3.4:

“Additional fixed fire-extinguishing systems not required by the Code, but fitted to the craft are to meet the design requirements of this Code, except for the second discharge required for fixed gas fire-extinguishing systems.”

87 In paragraph 7.7.3.3.3, the following text is added after the first sentence:

“Pipelines may pass through accommodation spaces, provided they are of substantial thickness and their tightness is verified with a pressure test, after their installation, at a pressure head not less than 5 N/mm². In addition, pipelines passing through accommodation areas shall only be joined by welding and shall not be fitted with drains or other openings within such spaces. Pipelines shall not pass through refrigerated spaces.”

88 The following sentence is added at the end of paragraph 7.7.3.3.5:

“Openings that may admit air to, or allow gas to escape from, a protected space shall be capable of being closed from outside the protected space.”

89 The following text is added at the end of paragraph 7.7.3.3.6:

“corresponding to the gross volume of the machinery space being increased by the volume of air receivers converted to free air volume. Alternatively, a discharge pipe connected to a safety valve may be fitted to each air receiver, provided it leads directly to the open air.”

90 In paragraph 7.7.3.3.7, the words “which personnel can be expected to enter (e.g., ro-ro spaces) and where their access is facilitated by doors or hatches or” are inserted after the words “work or” in the first sentence; and in the second sentence, the word “operate” is replaced by the words “automatically operate (e.g., by opening of the release cabinet door)”.

91 The following text is added at the end of paragraph 7.7.3.3.10:

“Spaces are considered as separated where divisions comply with tables 7.4-1 and 7.4-2, as appropriate, or the divisions are gastight and of steel or equivalent materials.”

92 The following text is added at the end of paragraph 7.7.3.3.12:

“without moving the containers completely from their fixing position.”

93 The existing paragraph 7.7.3.3.14 is replaced by the following:

“7.7.3.3.14 When the fire-extinguishing medium is stored outside a protected space, it shall be stored in a room which shall be situated in a safe and readily accessible location. For the purpose of the application of tables 7.4-1 and 7.4-2, such storage rooms shall be treated as control stations. For the storage rooms for fire-extinguishing media of fixed gas fire-extinguishing systems, the following apply:

- .1 the storage room shall not be used for any other purposes;

- .2 if the storage space is located below deck, it shall be located no more than one deck below the open deck and shall be directly accessible by a stairway or ladder from the open deck;
- .3 spaces shall be effectively ventilated. Spaces which are located below deck or spaces where access from the open deck is not provided, shall be fitted with a mechanical ventilation system designed to take exhaust air from the bottom of the space and shall be sized to provide at least 6 air changes per hour; and
- .4 access doors shall open outwards, and bulkheads and decks including doors and other means of closing any opening therein, which form the boundaries between such rooms and adjacent enclosed spaces shall be gastight.”

94 The following text is added at the end of paragraph 7.7.4:

“Each portable fire extinguisher shall:

- .1 not exceed 23 kg in total mass;
- .2 have a capacity of at least 5 kg if of powder or carbon dioxide type;
- .3 have a capacity of at least 9 l if of foam type;
- .4 be examined annually;
- .5 be provided with a sign indicating the date when was last examined;
- .6 be hydraulic-pressure tested (cylinders and propellant bottles) every 10 years;
- .7 not be placed in accommodation spaces if of carbon dioxide type;
- .8 if located in control stations and other spaces containing electrical or electronic equipment or appliances necessary for the safety of the craft, be provided with extinguishing media which are neither electrically conductive nor harmful to the equipment and appliances;
- .9 be ready for use and located in easily visible places such that it can be reached quickly and easily at any time in the event of a fire;
- .10 be located such that its serviceability is not impaired by the weather, vibration or other external factors; and
- .11 be provided with a device to identify whether it has been used.”

95 In paragraph 7.7.5.1, the words “independently driven pumps” are replaced by the words “pumps powered by independent sources of power”.

96 The following sentence is inserted before the last sentence of paragraph 7.7.5.3:

“The fire main shall be capable of being drained and shall be fitted with valves arranged so that fire main branches can be isolated when the main is used for purposes other than fire-fighting.”

97 The following text is added at the end of paragraph 7.7.5.4:

“One hydrant shall be located in the vicinity of and outside each entrance to a machinery space.”

98 In paragraph 7.7.5.5, the text after the words “non-perishable material” is replaced by the following:

“Fire hoses shall have a length of:

- .1 at least 10 m;
- .2 not more than 15 m in machinery spaces; and
- .3 not more than 20 m for other spaces and open decks.”

99 In paragraph 7.8.1.1, the words “Subject to 7.8.1.2” are inserted at the beginning and the second sentence is deleted.

100 The following new paragraph 7.8.1.2 is added after the existing paragraph 7.8.1.1 and the existing paragraphs 7.8.1.2 and 7.8.1.3 are renumbered as paragraphs 7.8.1.3 and 7.8.1.4:

“7.8.1.2 The vehicle deck of a special category space or a ro-ro space, including an open ro-ro space, need only be insulated on the underside if required. Vehicle decks located totally within ro-ro spaces may be accepted without structural fire protection, provided these decks are not part of, or do not provide support to, the craft’s main load-carrying structure and provided satisfactory measures are taken to ensure that the safety of the craft, including fire-fighting abilities, integrity of fire resisting divisions and means of evacuation, is not affected by a partial or total collapse of these internal decks.”

101 The first paragraph of 7.8.2 is renumbered 7.8.2.1 and the following text is inserted after paragraph 7.8.1:

“7.8.2.2 The pumps of the system shall be capable of maintaining:

- .1 half the total required application rate with any one pump unit out of function, for category A craft; and
- .2 the total required application rate with any one pump unit out of function, for category B craft.

7.8.2.3 Fixed fire-extinguishing systems shall fulfil the following requirements:

- .1 the valve manifold shall be provided with a pressure gauge, and each of the valves shall be marked to identify the protected areas;
- .2 instructions for maintenance and operation of the installation shall be set up in the room where the valves are located; and
- .3 the piping system shall be provided with a sufficient number of drainage valves.”

102 The following text is added at the end of paragraph 7.8.4.1:

“, which shall consist of a metal L-shaped pipe, the long limb being approximately 2 m in length and capable of being fitted to a fire hose, and the short limb being approximately 250 mm in length and fitted with a fixed water fog nozzle or capable of being fitted with a water spray nozzle;”

103 The following text is added at the end of paragraph 7.8.4.3:

“In addition to complying with 7.7.4, fire extinguishers shall be suitable for A and B class* fires and have a capacity of 12 kg dry powder or equivalent.”

104 Paragraph 7.8.6 is renumbered as paragraph 7.8.6.1 and the words “scuppers shall be fitted so” in the first sentence are replaced by the words “pumping and drainage arrangements shall be such as to prevent such accumulation. Scuppers fitted for this purpose shall be so arranged”.

105 The following new paragraph 7.8.6.2 is inserted after the existing paragraph 7.8.6.1:

“7.8.6.2 In respect of scuppers and drainage pumps fitted in accordance with 7.8.6.1:

- .1 the amount of water for which drainage is provided shall take into account the capacity of both the water spraying system pumps and required number of fire hose nozzles;
- .2 the drainage system shall have a capacity of not less than 125% of the capacity specified in .1 above; and
- .3 bilge wells shall be of sufficient holding capacity and shall be arranged at the side shell of the ship at a distance from each other of not more than 40 m in each watertight compartment.”

106 In paragraph 7.8.7.1, the text after the first sentence is replaced by the following:

“Electrical equipment installed more than 450 mm above the deck or platform shall be of a type enclosed and protected by an enclosure having an ingress protection based on an international standard acceptable to the Organization*. However, if the installation

* Refer to publication IEC 60529 – Degrees of protection provided by enclosures (IP Code), in particular, refer to the standards for an ingress protection of at least IP 55 or refer to the publication IEC 60079 series – Electrical apparatus for explosive gas atmospheres, in particular, refer to the standards for protection by an apparatus for use in zone 2 areas.

electrical equipment and wiring less than 450 mm above the deck or platform is necessary for the safe operation of the craft, such electrical equipment and wiring may be installed provided that the equipment is certified “safe type” based on an international standard acceptable to the Organization.* ”

* Refer to the publication IEC 60079 series – Electrical apparatus for explosive gas atmospheres, in particular, refer to the standards for equipment and wiring to be suitable for use in zone 1 areas.

107 The existing text of paragraph 7.8.7.2 is replaced by the following:

“7.8.7.2 If installed in an exhaust ventilation duct, electrical equipment shall be certified “safe type”.¹ The equipment and wiring, if fitted, shall be suitable for use based on standards acceptable to the Organization* and the outlet from any exhaust duct shall be sited in a safe position, having regard to other possible sources of ignition.”

108 In paragraph 7.10.1.2, the words “complying with the requirements of 7.8.4.1” are inserted after the words “water fog applicator”.

109 In paragraph 7.10.2, the words “or sets of personal equipment shall be so stored as” are replaced by the words “and sets of personal equipment shall be stored in permanently and clearly marked locations arranged so as”.

110 In paragraph 7.10.3.1.2, the words “and gloves” are deleted.

111 In paragraph 7.10.3.1.4, the word “type” is replaced by the words “explosion-proof type certified to a standard acceptable to the Organization***”.

112 The words “having handle provided with high-voltage insulation” are added at the end of paragraph 7.10.3.1.5.

113 Paragraphs 7.10.3.2 and 7.10.3.2.1 are deleted, the remaining paragraph 7.10.3.2.2 is renumbered as 7.10.3.2 and the words “of an approved type” are inserted after the words “breathing apparatus”.

114 The second sentence of the renumbered paragraph 7.10.3.2 is replaced by the following:

“Two spare charges suitable for use with the apparatus shall be provided for each required apparatus.”

115 In paragraph 7.10.3.3, the words “sufficient length” are replaced by the words “approximately 30 m in length” and the following new sentence is added at the end:

“The lifeline shall be subjected to a test by static load of 3.5 kN for 5 min.”

116 In paragraph 7.11.1.3, the words “within the structural fire protection time for areas of major fire hazard.” are added at the end.

¹ Refer to publication IEC 60092.

* Refer to zone 1 areas as defined in the publication IEC 60079 series.

** Refer to gas group II A and temperature class T 3 of the publication IEC 60079 series.

117 In paragraph 7.13.1, the following sentence is inserted after the first sentence:

“A stairway open at one deck shall be considered part of the space to which it is open and consequently shall be protected by any sprinkler system provided for that space.”

118 In paragraph 7.13.3, the words “operational speed” are replaced by the words “90% of maximum speed”.

119 The existing text of subparagraph .2 of paragraph 7.17.2.2 is replaced by the following:

“.2 purpose-built container craft and cargo spaces intended for the carriage of dangerous goods in freight containers and portable tanks. In this regard, a purpose-built container space is a cargo space fitted with cell guides for stowage and securing containers;”

120 In paragraph 7.17.2.3, the words “, including special category spaces,” are inserted after the words “ro-ro spaces”.

121 The following text is added at the end of paragraph 7.17.3:

“For the purpose of this section, “on deck” shall be taken to mean spaces on the weather deck.”

122 In paragraph 7.17.3.1.2, the word “supplying” is replaced by the words “simultaneously supplying the arrangements required by 7.17.3.1.3 for the largest designated cargo space and the” and the following sentence is inserted after the first sentence:

“This requirement shall be met by the total capacity of the main fire pump(s) not including the capacity of the emergency fire pump, if fitted.”

123 In the existing paragraph 7.17.3.1.3:

- .1 the words “shall be provided” are deleted from the end of the first sentence and are re-inserted after the first word “Means”;
- .2 the words “copious quantities of water” are replaced by the words “with water at not less than 5 l/min/m² of the horizontal area of cargo spaces”; and
- .3 the words “meet the requirements of 7.8.6 and” are inserted after the words “drainage and pumping arrangements shall”.

124 The following sentence is added at the end of paragraph 7.17.3.1.4:

“Substitution by a high expansion foam system complying with regulation II-2/10.4.1.1.2 of the Convention is also acceptable.”

125 The following new paragraphs 7.17.3.1.5 and 7.17.3.1.6 are added after existing paragraph 7.17.3.1.4:

“7.17.3.1.5 The requirements of 7.17.3.1.1 to 7.17.3.1.4 may be fulfilled by a water spray system approved by the Administration based on the standards developed by the Organization*, provided that the amount of water required for fire-fighting purposes in the largest cargo space allows simultaneous use of the water spray system plus four jets of water from hose nozzles in accordance with 7.17.3.1.2.

7.17.3.1.6 Craft carrying dangerous goods shall be provided with three fire hoses and nozzles complying with 7.7.5.6 in addition to those required by 7.7.5.5.”

* Refer to paragraphs 9.2, 9.3 and 9.4 of the Interim guidelines for open-top containerships (MSC/Circ.608/Rev.1).

126 In the first sentence of paragraph 7.17.3.2, the words “or vehicle decks” are added after the words “enclosed cargo spaces”.

127 In paragraph 7.17.3.4.2, the sentence “Exhaust fans shall be of non-sparking type.” is inserted after the first sentence and the text of the last sentence is replaced by the following:

“Suitable wire mesh guards having a mesh size not exceeding 13 mm x 13 mm shall be fitted over inlet and outlet ventilation openings to prevent foreign objects from entering into the casing.”

128 Existing paragraph 7.17.3.4.3 is renumbered as paragraph 7.17.3.4.4; the relevant reference in table 7.17-2 is amended; and the following new paragraph 7.17.3.4.3 is inserted:

“7.17.3.4.3 If adjacent spaces are not separated from cargo spaces by gastight bulkheads or decks, ventilation requirements shall apply to the adjacent spaces as for the cargo space itself.”

129 The following new paragraph 7.17.3.4.5 is added after the existing paragraph 7.17.3.4.4:

“7.17.3.4.5 For open-top container craft, power ventilation is required only for the lower part of the cargo hold for which purpose-built ducting is required. The ventilation rate shall be at least two air changes per hour based on the empty hold volume below the weather deck.”

130 In table 7.17-1, the words “(includes cargoes of group B of the Code of Safe Practice for Solid Bulk Cargoes, 2004, except for cargoes denoted Materials Hazardous in Bulk)” are added to the words “Solid dangerous goods in bulk” at the head of the right-hand column.

131 In table 7.17-1, the words “per hour” are added at the end of the second sentence of note 1.

132 In table 7.17-2, note 4, the words “residues of” are added after the word “containing”.

133 In table 7.17-2, the following note 7 is inserted with references from row 7.17.3.4.2, columns 4.2 and 4.3, and the existing notes 7 to 11 to table 7.17-3 together with their references in that table are renumbered as notes 8 to 12:

“7 For seedcake containing residues of solvent extraction and cargoes of BC Code Class 4.3, two separate fans shall be permanently fitted unless portable type fans have been adapted for being securely fitted (e.g., fixed) prior to loading and during the voyage. The ventilation system shall comply with the provisions of 7.17.3.4.1 and 7.17.3.4.2. Ventilation shall be such that any escaping gases cannot reach public spaces or crew accommodation on or under deck.”

134 In table 7.17-3, in the seventh and eighth columns, the references to “3.1 3.2” and “3.3” are replaced by the reference to “3” and the following new note 13 is added to “x” in column “5.2”, last and penultimate lines:

“Under the provisions of the IMDG Code, stowage of class 5.2 dangerous goods under deck or in enclosed ro-ro spaces is prohibited.”

135 At the end of the existing paragraph 7.17.3.5, the following new text is added:

“as follows:

- .1 if the bilge drainage system for cargo spaces is additional to the system served by pumps in the machinery space, the capacity of the system shall be not less than than 10 m³/h per cargo space served. If the additional system is a common system, the capacity need not exceed 25 m³/h. The additional bilge system need not be arranged with redundancy. Whenever flammable or toxic liquids are carried, the bilge line into the machinery space shall be isolated either by fitting a blank flange or by a closed lockable valve;
- .2 if bilge drainage of cargo spaces is arranged by gravity drainage, the drainage shall be either lead directly overboard or to a closed drain tank located outside the machinery spaces. The tank shall be provided with vent pipe to a safe location on the open deck;
- .3 enclosed spaces outside machinery spaces containing bilge pumps serving cargo spaces intended for carriage of flammable or toxic liquids shall be fitted with separate mechanical ventilation giving at least six air changes per hour. Electrical equipment in the space shall be of certified safe type.* If the space has access from another enclosed space, the door shall be self-closing; and
- .4 drainage from a cargo space into bilge wells in a lower space is only permitted if that space satisfies the same requirements as the cargo space above.”

* Refer to publication IEC 60092-506: Special features – Ships carrying dangerous goods and materials hazardous only in bulk.

136 The following text is added at the end of the first sentence of paragraph 7.17.3.6.1:

“and shall be selected taking into account the hazards associated with the chemicals being transported and the standards developed by the Organization according to the class and physical state.”

137 The following new sentence is added at the end of paragraph 7.17.3.6.2:

“In addition to the requirements of 7.10.3.2.2, two spare charges suitable for use with the breathing apparatus shall be provided for each required apparatus.”

138 In paragraph 7.17.3.8.2, the words “meet the requirements of 7.8.6, have valves operable from outside the space at a position in the vicinity of the extinguishing system controls and” are inserted after the words “drainage and pumping arrangements shall”.

CHAPTER 8 LIFE-SAVING APPLIANCES AND ARRANGEMENTS

139 Existing paragraphs 8.7.6 to 8.7.10 are renumbered as paragraphs 8.7.7 to 8.7.11 and the following new paragraph 8.7.6 is inserted:

“8.7.6 Where an MES is provided for embarkation into survival craft on a category B craft, an alternative means of evacuating passengers and crew into survival craft on the same side of the craft in conditions up to and including the worst intended conditions is to be provided for use if the MES is lost or rendered unserviceable in the event of damage of longitudinal extent specified in 2.6.7.1.”

140 In paragraph 8.9.14.2, after the word “shall”, the words “be subject to a thorough examination at the annual surveys required by paragraph 1.5.1.3” are added and the remainder of the sentence is deleted.

141 In paragraph 8.9.14.3, after word “brake”, the words “at maximum lowering speed. The load to be applied shall be the mass of the survival craft or rescue boat without persons on board, except that, at intervals not exceeding five years, the test shall be carried out with a proof load equal to 1.1 times the weight of the survival craft or rescue boat and its full complement of persons and equipment.” are added and the remainder of the sentence is deleted.

CHAPTER 10 AUXILIARY SYSTEMS

142 In paragraph 10.2.4.8, the words “the filling pipes” at the end of the first sentence are replaced by the words “bunkering pipes and any filling pipes served by on-board pumps”; and the words “and, for fuel of flashpoint less than 43°C,” are replaced by the words “where there is no risk of fire or explosion from the emergence of oils and vapour, shall not lead into crew spaces, passenger spaces, special category spaces, ro-ro spaces (other than open ro-ro spaces), machinery spaces or similar spaces. For fuel of flashpoint less than 43°C such valves and pipes”.

CHAPTER 11 REMOTE CONTROL, ALARM AND SAFETY SYSTEMS

143 In paragraph 11.3.3, in the first sentence, the words “in a station” are replaced by the words “at one or more stations”.

144 In paragraph 11.4.1.2, subparagraphs .4 to .11 are renumbered as subparagraphs .5 to .12 and the following new subparagraph .4 is inserted after the existing subparagraph .3:

“.4 detection of bilge water in each watertight compartment below the design waterline;”

CHAPTER 13 SHIPBORNE NAVIGATIONAL SYSTEMS AND EQUIPMENT AND VOYAGE DATA RECORDERS

145 The existing paragraph 13.8.2 is renumbered as paragraph 13.8.3 and the following new paragraph 13.8.2 is inserted:

“13.8.2 High-speed craft shall be fitted with an ECDIS as follows:

- .1 craft constructed on or after 1 July 2008;
- .2 craft constructed before 1 July 2008, not later than 1 July 2010.”

CHAPTER 14 RADIOCOMMUNICATIONS

146 The existing text of paragraph 14.15.10 is replaced by the following:

“14.15.10 Satellite EPIRBs on all craft shall be:

- .1 annually tested for all aspects of operational efficiency, with special emphasis on checking the emission on operational frequencies, coding and registration, at intervals as specified below:
 - .1 on passenger craft, within 3 months before the expiry date of the High-Speed Craft Safety Certificate; and
 - .2 on cargo craft, within 3 months before the expiry date, or 3 months before or after the anniversary date, of the High-Speed Craft Safety Certificate;

The test may be conducted on board the craft or at an approved testing station; and

- .2 subject to maintenance at intervals not exceeding five years, to be performed at an approved shore-based maintenance facility.”

CHAPTER 18 OPERATIONAL REQUIREMENTS

147 The existing text of subparagraph .4 of paragraph 18.1.3.4 is replaced by the following:

“.4 provision in the area of operation of a base port having functions and facilities in accordance with the requirements of this Code;”

ANNEX 1
FORM OF HIGH-SPEED CRAFT SAFETY CERTIFICATE
AND RECORD OF EQUIPMENT

148 In the Record of Equipment for High-Speed Craft Safety Certificate, in section 3, the following new item 16 is inserted after the existing item 15 and the existing item 16 is renumbered as 17.

“16 Long-range identification and tracking system”

149 In the Record of Equipment for High-Speed Craft Safety Certificate, section 4, the words “Two-way on-scene radiocommunications 121.5 MHz & 123.1 MHz” are inserted as item 7.

ANNEX 6
STABILITY OF HYDROFOIL CRAFT

150 In the chapeau paragraph, the following new paragraphs are inserted after the existing introductory paragraph and prior to paragraph 1:

“As required by 2.3.1, the stability of hydrofoil craft shall be assessed under all permitted conditions of loading.

The term “hull-borne mode” has the same meaning as “displacement mode” defined in 1.4.22 of the Code.

The term “foil-borne mode” has the same meaning as “non-displacement mode” defined in 1.4.38 of the Code.”

ANNEX 7
STABILITY OF MULTIHULL CRAFT

151 At the end of paragraph 1.4.2, the following sentence is added:

“Alternatively, another method of assessment may be employed, as provided for in 2.1.4 of this Code.”

152 At the end of paragraph 1.5, the following sentence is added:

“The determination of θ_r using model test or other data shall be made using the method for determining θ_z in 1.1.5.3 of annex 6.”

153 At the end of paragraph 2.3, the words “, as determined in 1.5 of this annex” are added.

ANNEX 8
STABILITY OF MONOHULL CRAFT

154 The existing text of paragraph 1.1 is replaced by the following:

“1.1 The weather criterion contained in paragraph 3.2 of the Intact Stability Code* shall apply. In applying the weather criterion, the value of wind pressure P (N/m²) shall be taken as:

$$500\{V_w/26\}^2$$

where V_w = wind speed (m/s) corresponding to the worst intended conditions.

The angle of heel due to wind, in applying paragraph 3.2.2.1.2 of the Intact Stability Code, shall not exceed 16° or 80% of the angle of deck-edge immersion (whichever is less). Where the angle of heel due to wind exceeds 10°, efficient non-slip deck surfaces and suitable holding points shall be provided, in accordance with paragraph 2.13.1.1 of this Code. In applying the weather criterion, account shall also be taken of the roll damping characteristics of individual craft in assessing the assumed roll angle θ_1 , which may alternatively be derived from model or full scale tests using the method for determining θ_z in 1.1.5.3 of annex 6. Hulls with features which greatly increase damping, such as immersed sidehulls, substantial arrays of foils, or flexible skirts or seals, are likely to experience significantly smaller magnitudes of roll angle. For such craft, therefore, the roll angle shall be derived from model or full scale tests or, in the absence of such data, shall be taken as 15°.”

* Refer to the Code on Intact Stability for All Types of Ships Covered by IMO Instruments, adopted by the Organization by resolution A.749(18), as amended by resolution MSC.75(69).

155 The following new sentence is added at the end of paragraph 2.1.1:

“The range shall be taken as the difference between the equilibrium heel angle and the heel angle at which the residual righting lever subsequently becomes negative or the angle at which progressive flooding occurs, whichever is less.”

ANNEX 9 DEFINITIONS, REQUIREMENTS AND COMPLIANCE CRITERIA RELATED TO OPERATIONAL AND SAFETY PERFORMANCE

156 In the second sentence of the first paragraph, the word “prototype” is replaced by the word “first”.

157 In paragraphs 2.1.1, 2.1.2, 2.1.3 and 3.3.1, the words “maximum operational speed” are replaced by the words “90% of maximum speed”.

158 In paragraph 3.2, the sentence “The worst intended conditions shall not exceed 150% of the more severe of the two measured sea conditions” is inserted as the penultimate sentence.

ANNEX 10 CRITERIA FOR TESTING AND EVALUATION OF SEATS

159 In the title, the words “REVENUE AND CREW” are deleted.

160 In paragraph 3.4, the words “same strength and stiffness” are replaced by the words “equivalent strength and stiffness”.

- 161 In paragraph 3.6, after the words “and measurement,” the words “if possible” are deleted.
- 162 In paragraph 3.9, the following subparagraphs .3.3 to .3.5 are inserted after the existing subparagraph .3.2 and the existing subparagraph .3.3 is renumbered as subparagraph.3.6:
- “.3.3 neck flexion does not exceed 88 Nm;
- .3.4 neck extension does not exceed 48 Nm;
- .3.5 in lieu of the requirements of subparagraphs .3.3 and .3.4 above, a seatback or headrest of at least 850 mm above the seat cushion is acceptable; and”.
- 163 The following new annex 12 is added after the existing annex 11:

“ANNEX 12

FACTORS TO BE CONSIDERED IN DETERMINING CRAFT OPERATING LIMITATIONS*

1 Purpose and scope

The purpose of this annex is to identify the parameters to which consideration should be given when determining the worst intended conditions (defined in 1.4.61) and other operational limitations (defined in 1.4.41) for insertion into the Permit to Operate, in order to facilitate consistent application of the Code.

2 Factors to be considered

As a minimum, the following factors shall be considered:

- .1 The maximum distance from refuge implied by 1.3.4.
- .2 The availability of rescue resources to comply with 1.4.12.1 (category A craft only).
- .3 Minimum air temperature (susceptibility to icing), visibility and depth of water for safe operation as addressed by 1.4.61.
- .4 The significant wave height and maximum mean wind speed used when applying the requirements for stability and buoyancy in chapter 2 and associated annexes.
- .5 The safe seakeeping limitations (especially significant wave height) considering the known stability hazards listed in 2.1.5, the operating conditions on the intended route (see 18.1.3.2) and the motions experienced during operation defined in 3.3 of annex 9.

* Refer to the guidelines to be developed by the Organization.

- .6 The structural safety of the craft in critical design conditions according to chapter 3.
- .7 The safe deployment and operation of evacuation systems and survival craft as required by 8.6.5.
- .8 The safe handling limitations determined in accordance with the sea trials required by chapter 17 and annexes 3 and 9, identifying any limitations on weight and centre-of-gravity position according to 17.3, and the effects of failures and malfunctions according to 17.4.”
